

PCAN-USB

CAN Interface for USB

User Manual

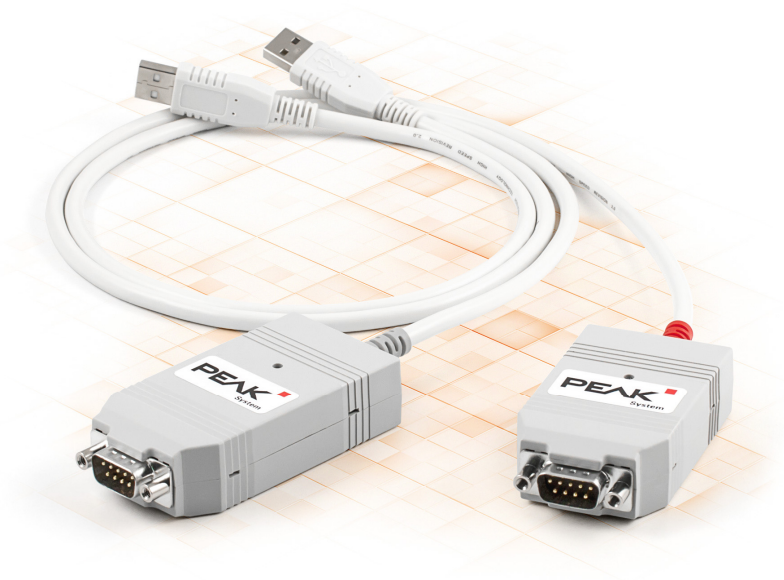

Document version 2.6.0 (2019-03-05)



Relevant products

Product name	Model	Part number
PCAN-USB		IPEH-002021
PCAN-USB opto-decoupled	Galvanic isolation for CAN interface	IPEH-002022

The cover picture shows both products: the PCAN-USB with the red and the PCAN-USB opto-decoupled with the grey cable strain relief.

PCAN® is a registered trademark of PEAK-System Technik GmbH. CANopen® and CiA® are registered community trade marks of CAN in Automation e.V.

All other product names mentioned in this document may be the trademarks or registered trademarks of their respective companies. They are not explicitly marked by "™" or "®".

Copyright © 2019 PEAK-System Technik GmbH

Duplication (copying, printing, or other forms) and the electronic distribution of this document is only allowed with explicit permission of PEAK-System Technik GmbH. PEAK-System Technik GmbH reserves the right to change technical data without prior announcement. The general business conditions and the regulations of the license agreement apply. All rights are reserved.

PEAK-System Technik GmbH
Otto-Roehm-Strasse 69
64293 Darmstadt
Germany

Phone: +49 (0)6151 8173-20
Fax: +49 (0)6151 8173-29

www.peak-system.com
info@peak-system.com

Document version 2.6.0 (2019-03-05)

Contents

1	Introduction	5
1.1	Properties at a Glance	5
1.2	System Requirements	6
1.3	Scope of Supply	7
2	Installing the Software and the Adapter	8
3	Connecting the CAN Bus	9
3.1	Connection over D-Sub Connector	9
3.2	Voltage Supply of External Devices	10
3.3	Activating the Internal Termination	13
3.4	Cabling	15
3.4.1	Termination	15
3.4.2	Example of a Connection	15
3.4.3	Maximum Bus Length	16
4	Operation	17
4.1	Status LED	17
4.2	Unplugging the USB Connection	17
4.3	Distinguishing Several PCAN-USB Adapters	17
5	Software and API	18
5.1	Monitor Software PCAN-View	18
5.1.1	Receive/Transmit Tab	20
5.1.2	Trace Tab	22
5.1.3	PCAN-USB Tab	23
5.1.4	Status Bar	24
5.2	Linking Own Programs with PCAN-Basic	25
5.2.1	Features of PCAN-Basic	26
5.2.2	Principle Description of the API	27

5.2.3	Notes about the License	28
6	Technical Specifications	29
Appendix A	CE Certificate	31
Appendix B	Dimension Drawings	32
Appendix C	Quick Reference	33

1 Introduction

The PCAN-USB adapter enables simple connection to CAN networks. Its compact plastic casing makes it suitable for mobile applications. The opto-decoupled version guarantees galvanic isolation of up to 500 Volts between the PC and the CAN side.

The package is also supplied with the CAN monitor PCAN-View for Windows and the programming interface PCAN-Basic.

Device drivers exist for different operating systems, so programs can easily access a connected CAN bus.



Tip: At the end of this manual (Appendix C) you can find a Quick Reference with brief information about the installation and operation of the PCAN-USB adapter.

1.1 Properties at a Glance

- Adapter for the USB connection (Full-Speed mode, compatible with USB 1.1, USB 2.0, and USB 3.0)
- High-Speed CAN connection (ISO 11898-2)
- Bit rates from 5 kbit/s up to 1 Mbit/s
- Time stamp resolution approx. 42 μ s
- Compliant with CAN specifications 2.0A (11-Bit ID) and 2.0B (29-Bit ID)
- CAN-Bus connection via D-Sub, 9-pin (in accordance with CiA® 303-1)
- NXP SJA1000 CAN controller, 16 MHz clock frequency
- NXP PCA82C251 CAN transceiver

- └ Galvanic isolation on the CAN connection up to 500 V (only PCAN-USB opto-decoupled)
- └ 5-Volts supply to the CAN connection can be connected through a solder jumper, e.g. for external bus converter
- └ Voltage supply via USB
- └ Extended operating temperature range from -40 to 85 °C (-40 to 185 °F)

 **Note:** This manual describes the use of PCAN-USB adapter with **Windows**. You can find device drivers for **Linux** and the corresponding application information on the provided DVD in the directory branch `Develop` and on our website under www.peak-system.com/linux.

1.2 System Requirements

- └ A vacant USB port (USB 1.1, USB 2.0 or USB 3.0) at the computer or at a self-powered USB hub connected to the computer
- └ Operating system Windows 10, 8.1, 7 (32/64-bit) or Windows CE 6.x (x86 and ARMv4 processor support) or Linux (32/64-bit)

 **Note:** Do not use a USB extension cable to connect the PCAN-USB adapter to the computer. The use of an extension cable does not comply with the USB specification and can lead to malfunction of the adapter.

1.3 Scope of Supply

- └ PCAN-USB in plastic casing
- └ Device drivers for Windows 10, 8.1, 7 and Linux (32/64-bit)
- └ Device driver for Windows CE 6.x (x86 and ARMv4 processor support)
- └ CAN monitor PCAN-View for Windows
- └ Programming interface PCAN-Basic for developing applications with CAN connection
- └ Programming interfaces for standardized protocols from the automotive sector
- └ Manual in PDF format

2 Installing the Software and the Adapter

This chapter covers the software setup for the PCAN-USB adapter under Windows and the connection of the adapter to the computer.

Install the driver before you connect the adapter to the computer.

▶ Do the following to install the driver:

1. Start `Intro.exe` from the supplied DVD.
The navigation program starts.
2. Select in the main menu **Drivers** and click on **Install now**.
3. Confirm the message of the User Account Control related to "Installer database of PEAK Drivers".
The driver setup starts.
4. Follow the program instructions.

▶ Do the following to connect the adapter:

 **Note:** Do not use a USB extension cable to connect the PCAN-USB adapter to the computer. The use of an extension cable does not comply with the USB specification and can lead to malfunction of the adapter.

1. Connect the adapter to a USB port of the computer or of a connected USB hub. The computer can remain powered on.
Windows detects the new hardware and completes the driver installation.
2. Check the LED on the adapter. If the LED is red, then the driver was initialized successfully.

3 Connecting the CAN Bus

3.1 Connection over D-Sub Connector

A High-speed CAN bus (ISO 11898-2) is connected to the 9-pin D-Sub connector. The pin assignment for CAN corresponds to the specification CiA® 303-1.

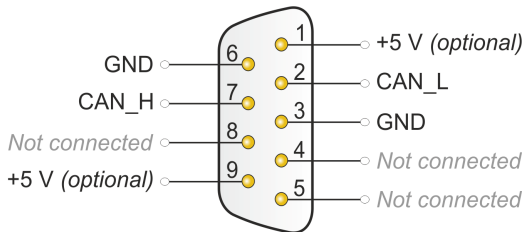

Figure 1: Pin assignment High-speed CAN
(view onto connector of the PCAN-USB adapter)

Low power devices (e.g. bus converters) can be supplied directly with 5 volts over pin 1 and pin 9 of the CAN connector. Pin 1 and pin 9 is not in use at the delivery state. For more information see the next section 3.2.



Tip: You can connect a CAN bus with a different transmission standard via a bus converter. PEAK-System offers different bus converter modules (e.g. PCAN-TJA1054 for a Low-speed CAN bus according to ISO 11898-3).

3.2 Voltage Supply of External Devices

External devices with low power consumption (e.g. bus converters) can be directly supplied via the CAN connector. With a solder bridge for the one CAN channel on the PCAN-USB board (casing opened), a 5-Volt supply can optionally be routed to pin 1 and/or pin 9 of the D-Sub connector (for PCAN-USB opto-decoupled to S/N 199999 only pin 1 available).

The opto-decoupled model of the adapter contains an interconnected DC/DC converter. Therefore, the current output is limited to 50 mA.



Risk of short circuit! The 5-Volt supply is not protected separately. Therefore, turn off the computer before you connect and disconnect CAN cables or peripheral systems.

Consider that some computers still supply the USB ports with power even when they are turned off (standby operation).



Do the following to activate the voltage supply:



Risk of short circuit! Solder with great care to avoid unwanted short circuits on the card.



Attention! Electrostatic discharge (ESD) can damage or destroy components on the circuit board. Take precautions to avoid ESD while handling the circuit board.

1. Open the adapter casing. Push the latches on both sides cautiously, e.g. with a flat tip screwdriver.
2. Remove the circuit board.
3. Set the solder bridge according to the model of the PCAN-USB on the intended position on the circuit board (see figures and table below).

4. Place the board overhead onto the top part of the casing. The cable must lie with the strain relief in the cut-out of the casing and the LED must be in the corresponding hole.
5. Push the bottom part of the casing onto the top part until the latches click in.

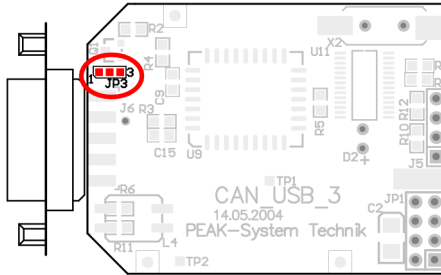

Figure 2: PCAN-USB board (IPEH-002021) to S/N 199999, solder field JP3 for 5-Volt supply

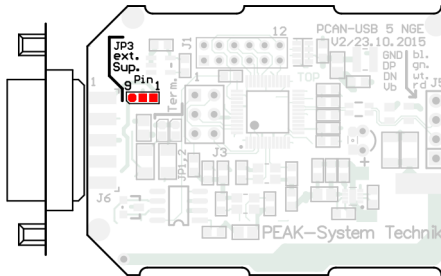

Figure 3: PCAN-USB board (IPEH-002021) from S/N 200000, solder field JP3 for 5-Volt supply

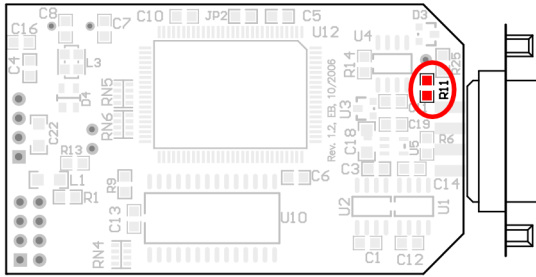

Figure 4: Bottom side of the PCAN-USB opto-decoupled board (IPEH-002022) to S/N 199999, solder field R11 for 5-Volt supply

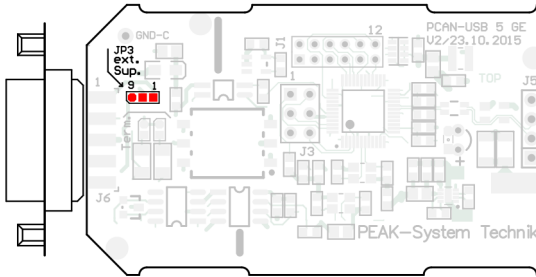

Figure 5: PCAN-USB opto-decoupled board (IPEH-002022) from S/N 200000, solder field JP3 for 5-Volt supply

PCAN-USB model	Solder field	5-Volt supply on the D-Sub connector			
		Without (default)	Pin 1	Pin 9	Pin 1 and pin 9
IPEH-2021 to S/N 199999	JP3				
IPEH-2021 from S/N 200000	JP3				
IPEH-2022 (opto-dec.) to S/N 199999	R11			not applicable	not applicable
IPEH-2022 (opto-dec.) from S/N 200000	JP3				

3.3 Activating the Internal Termination

Only applicable to adapters from S/N 200000.

The internal termination can be activated by solder jumpers on the circuit board to terminate one end of the CAN bus. At delivery the termination is not activated. A High-speed CAN bus (ISO 11898-2) must be terminated on both ends with 120 Ohms. Otherwise disturbances may arise.

▶ Do the following to activate the internal termination:



Risk of short circuit! Solder with great care to avoid unwanted short circuits on the card.



Attention! Electrostatic discharge (ESD) can damage or destroy components on the circuit board. Take precautions to avoid ESD while handling the circuit board.

1. Open the adapter casing. Push the latches on both sides cautiously, e.g. with a flat tip screwdriver.
2. Remove the circuit board.
3. Set both solder bridges. The following figures show the positions of the solder fields.
4. Place the board overhead onto the top part of the casing. The cable must lie with the strain relief in the cut-out of the casing and the LED must be in the corresponding hole.
5. Push the bottom part of the casing onto the top part until the latches click in.

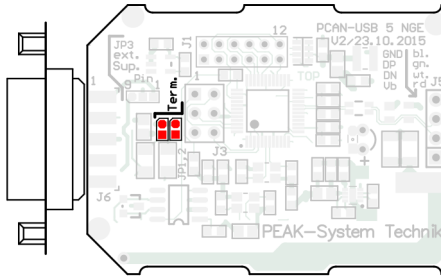

Figure 6: PCAN-USB board (IPEH-002021) to S/N 199999, solder fields for the CAN bus termination

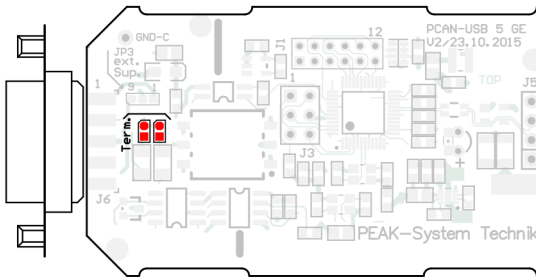

Figure 7: PCAN-USB opto-decoupled board (IPEH-002022) from S/N 200000, solder fields for the CAN bus termination

PCAN-USB model	Termination High-speed CAN bus 120 Ω	
	Without (default)	Activated
IPEH-2021 to S/N 199999	Not available	
IPEH-2021 from S/N 200000		
IPEH-2022 (opto-dec.) to S/N 199999	Not available	
IPEH-2022 (opto-dec.) from S/N 200000		

3.4 Cabling

3.4.1 Termination

The High-speed CAN bus (ISO 11898-2) must be terminated with 120 ohms on both ends. The termination prevents interfering signal reflections and ensures the proper operation of the transceivers of the connected CAN nodes (CAN interfaces, control devices).

The PCAN-USB adapter to S/N 199999 does not have an internal termination. From S/N 200000 it has an optional internal termination with 120 Ohms. See the previous section 3.3 for information about activation.

3.4.2 Example of a Connection

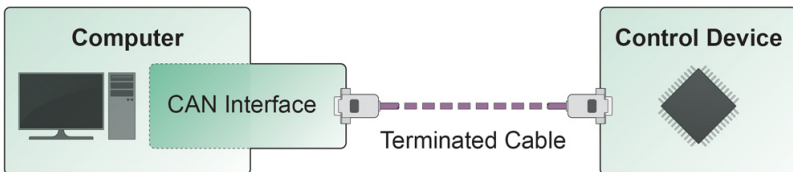

Figure 8: Simple CAN connection

This example shows a connection between the PCAN-USB adapter and a control unit. The connection cable is terminated with 120 ohms at both ends.

3.4.3 Maximum Bus Length

High-Speed-CAN networks may have bit rates of up to 1 Mbit/s. The maximum bus length depends primarily on the bit rate.

The following table shows the maximum possible CAN bus length at different bit rates:

Bit rate	Bus length
1 Mbit/s	40 m
500 kbit/s	110 m
250 kbit/s	240 m
125 kbit/s	500 m
50 kbit/s	1.3 km
20 kbit/s	3.3 km
10 kbit/s	6.6 km
5 kbit/s	13.0 km

The listed values have been calculated on the basis of an idealized system and can differ from reality.

4 Operation

4.1 Status LED

The PCAN-USB adapter has a red status LED which can be in one of the following conditions:

Status	Meaning
On	There's a connection to a driver of the operating system.
Slow blinking	A software application is connected to the adapter.
Quick blinking	Data is transmitted via the connected CAN bus.

4.2 Unplugging the USB Connection

Under Windows the icon for removing hardware safely is not used with the PCAN-USB adapter. You can unplug the adapter from the computer without any preparation.

4.3 Distinguishing Several PCAN-USB Adapters

You can operate several PCAN-USB adapters on a single computer at the same time. The supplied program PCAN-View allows the assignment of device IDs in order to distinguish the adapters in a software environment. For more information see section 5.1.3 on page 23.

5 software and API

This chapter covers the provided software PCAN-View and the programming interface PCAN-Basic.

5.1 Monitor Software PCAN-View

PCAN-View is simple Windows software for viewing, transmitting, and logging CAN and CAN FD messages.



Note: This chapter describes the use of PCAN-View with a CAN adapter.

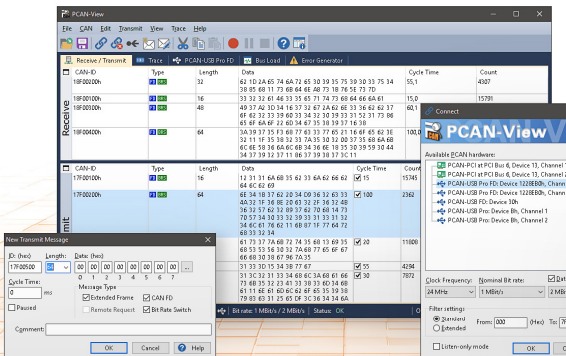

Figure 9: PCAN-View for Windows

▶ Do the following to start and initialize PCAN-View:

1. Open the Windows Start menu and select **PCAN-View**.

The **Connect** dialog box appears.

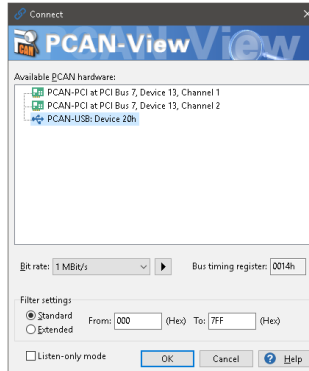

Figure 10: Selection of the specific hardware and parameters

2. Select an interface from the list.
3. From the dropdown list, select the **Bit rate** that is used by all nodes on the CAN bus.



Tip: You can create custom bit rates by using the button (▶).

4. Under **Filter settings** you can limit the range of CAN IDs to be received, either for standard frames (11-bit IDs) or for extended frames (29-bit IDs).
5. Activate the **Listen-only mode** if you do not actively participate in the CAN traffic and just want to observe. This also avoids an unintended disruption of an unknown CAN environment (e.g. due to different bit rates).
6. Confirm the settings in the dialog box with **OK**. The main window of PCAN-View appears (see Figure 11).

5.1.1 Receive/Transmit Tab

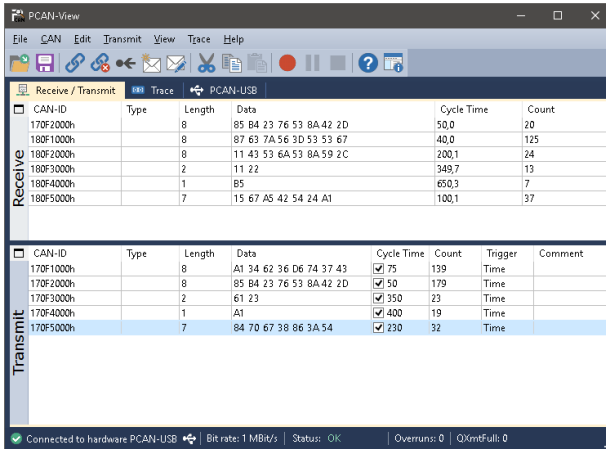

Figure 11: Receive/Transmit tab

The **Receive/Transmit** tab is the main element of PCAN-View. It contains two lists, one for received messages and one for the transmit messages. The CAN data format is hexadecimal by default.

▶ Do the following to transmit a CAN message with PCAN-View:

1. Select the menu command **Transmit > New Message** (alternatively or **Ins**).

The **New Transmit Message** dialog box appears.

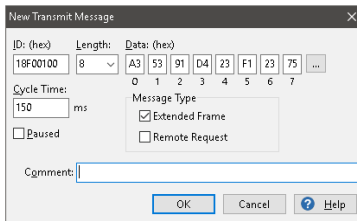

Figure 12: Dialog box new transmit message

2. Enter the **ID**, the data **Length** and the CAN message **Data**.



Note: With the program version 4 of PCAN-View, the DLC field was renamed to **Length**. Latter reflects the actual data length.

3. Enter a value into the **Cycle Time** field to choose manually or periodically message transmission. Enter a value greater than 0 to transmit periodically. Enter the value 0 to transmit only manually.

4. Confirm the entries with **OK**.

The created transmit message appears on the **Receive/Transmit** tab.

5. Trigger selected transmit messages manually with the menu command **Transmit > Send** (alternatively bar). The manual transmission for CAN messages being transmitted periodically is carried out additionally.



Tip: Under the menu command **File > Save**, you can save the current transmit messages into a transmit list. Saved transmit lists are available for reuse.

5.1.2 Trace Tab

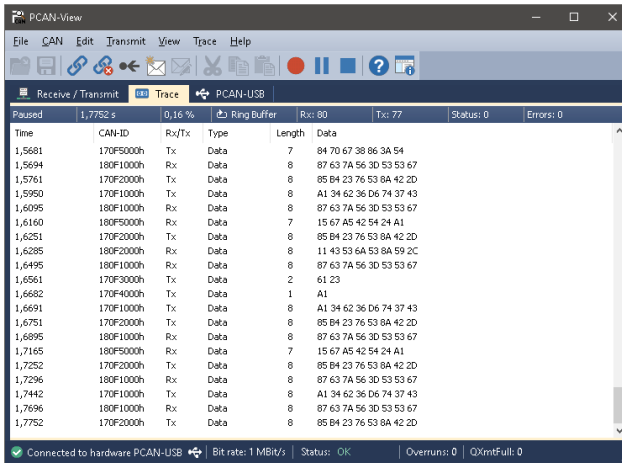

Figure 13: Trace tab

On the **Trace** tab, the data tracer (data logger) of PCAN-View is used for logging the communication on a CAN bus. During this process the messages are cached in the working memory of the PC. Afterwards, they can be saved to a file.

The Tracer runs either in linear or in ring buffer mode. The linear buffer mode stops the Tracer as soon as the buffer is full. The ring buffer mode overwrites the oldest messages by new ones as soon as the buffer is full.

5.1.3 PCAN-USB Tab

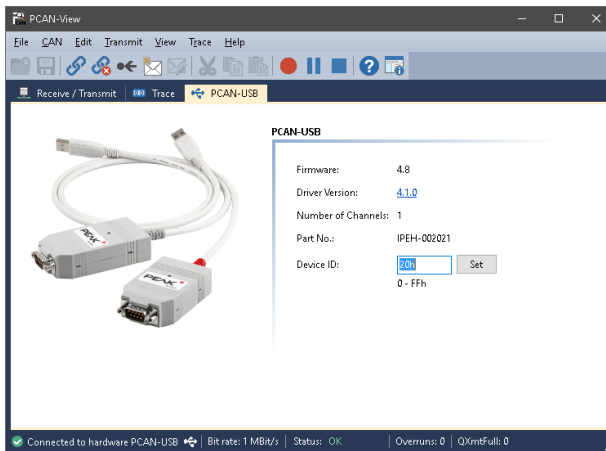

Figure 14: PCAN-USB tab

The **PCAN-USB** tab contains some detailed information about the hardware and driver. In addition, you can assign a device ID to the adapter. Thus, it can be uniquely identified while operating several PCAN-USB adapters on a computer at the same time.

To identify a PCAN-USB adapter, you first go to the dialog box for selecting the hardware of PCAN-View (Figure 10 on page 19). In the list **Available PCAN hardware and PCAN-nets**, you can perform a right-click on every USB adapter and execute the command "identify". Thereby the LED of the corresponding adapter flashes shortly.

5.1.4 Status Bar



Figure 15: Display of the status bar

The status bar shows information about the current CAN connection, about error counters (Overruns, QXmtFull) and shows error messages.

You can find further information about the use of PCAN-View in the help which you can invoke in the program via the **Help** menu or with the **F1** key.

5.2 Linking Own Programs with PCAN-Basic

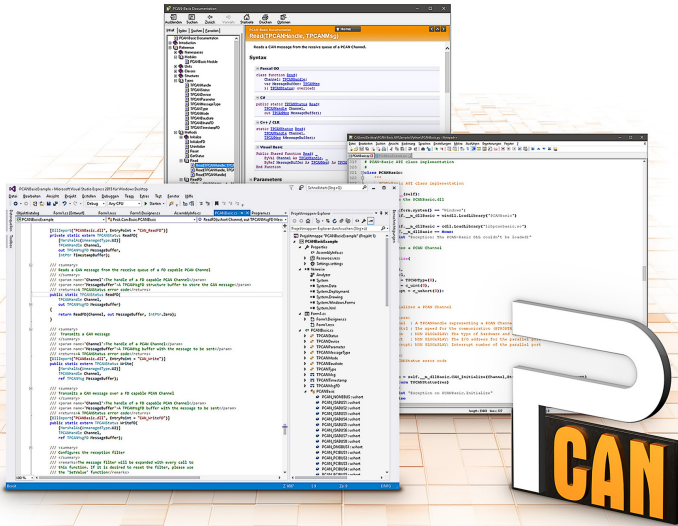

Figure 16: PCAN-Basic

On the provided DVD, you can find files of the PCAN-Basic programming interface in the directory branch `Develop`. This API provides basic functions for linking own programs to CAN and CAN FD interfaces by PEAK-System and can be used for the following operating systems:

- Windows 10, 8.1, 7 (32/64-bit)
- Windows CE 6.x (x86/ARMv4)
- Linux (32/64-bit)

The API is designed for cross-platform use. Therefore software projects can easily be ported between platforms with low efforts. For all common programming languages examples are available.

Beginning with version 4, PCAN-Basic supports the new CAN FD standard (CAN with Flexible Data Rate) which is primarily characterized by higher bandwidth for data transfer.

5.2.1 Features of PCAN-Basic

- └ API for developing applications with CAN and CAN FD connection
- └ Access to the CAN channels of a PCAN-Gateway via the new PCAN-LAN device type
- └ Supports the operating systems Windows 10, 8.1, 7 (32/64-bit), Windows CE 6.x, and Linux (32/64-bit)
- └ Multiple PEAK-System applications and your own can be operated on a physical channel at the same time
- └ Use of a single DLL for all supported hardware types
- └ Use of up to 16 channels for each hardware unit (depending on the PEAK CAN interface used)
- └ Simple switching between the channels of a PEAK CAN interface
- └ Driver-internal buffer for 32,768 messages per CAN channel
- └ Precision of time stamps on received messages up to 1 μ s (depending on the PEAK CAN interface used)
- └ Supports PEAK-System's trace formats version 1.1 and 2.0 (for CAN FD applications)
- └ Access to specific hardware parameters, such as listen-only mode
- └ Notification of the application through Windows events when a message is received
- └ Extended system for debugging operations
- └ Multilingual debugging output

- Output language depends on operating systems
- Debugging information can be defined individually
- Thread-safe API



Tip: An overview of the API functions is located in the header files. You can find detailed information about the PCAN-Basic API on the provided DVD in the text and help files (file name extensions `.txt` and `.chm`).

5.2.2 Principle Description of the API

The PCAN-Basic API is the interface between the user application and device driver. In Windows operating systems this is a DLL (Dynamic Link Library).

The sequence of accessing the CAN interface is divided into three phases:

1. Initialization
2. Interaction
3. Completion

Initialization

A channel must be initialized before using it. This is done by the simple call of the function `CAN_Initialize` for CAN and `CAN_InitializeFD` for CAN FD. Depending on the type of the CAN hardware, up to 16 CAN channels can be opened at the same time. After a successful initialization the CAN channel is ready. No further configuration steps are required.

Interaction

For receiving and transmitting messages the functions `CAN_Read` and `CAN_Write` as well as `CAN_ReadFD` and `CAN_WriteFD` are available. Additional settings can be made, e.g. setting up message filters to

confine to specific CAN IDs or setting the CAN controller to listen-only mode.

When receiving CAN messages, events are used for an automatic notification of an application (client). This offers the following advantages:

- └ The application no longer needs to check for received messages periodically (no polling).
- └ The response time at reception is reduced.

Completion

To end the communication the function `CAN_Uninitialize` is called in order to release the reserved resources for the CAN channel, among others. In addition the CAN channel is marked as "Free" and is available to other applications.

5.2.3 Notes about the License

Device drivers, the interface DLL, and further files needed for linking are property of the PEAK-System Technik GmbH and may be used only in connection with a hardware component purchased from PEAK-System or one of its partners. If a CAN hardware component of third-party suppliers should be compatible to one of PEAK-System, then you are not allowed to use or to pass on the driver software of PEAK-System.

If a third-party supplier develops software based on the PCAN-Basic and problems occur during the use of this software, consult the software provider.

6 Technical specifications

Connectors

Computer	USB plug type A
CAN	D-Sub (m), 9 pins Pin assignment according to specification CiA® 303-1

USB

Type	to S/N 199999 USB 1.1, from S/N 200000 USB 2.0, Full-Speed mode (compatible with USB 1.1, USB 2.0, and USB 3.0)
------	---

CAN

Specification	ISO 11898-2, High-speed CAN 2.0A (standard format) and 2.0B (extended format)
Bit rates	5 kbit/s - 1 Mbit/s
Controller	NXP SJA1000
Transceiver	NXP PCA82C251
Galvanic isolation	PCAN-USB: none PCAN-USB opto: up to 500 V
Supplying external devices	PCAN-USB: D-Sub pin 1/pin 9; 5 V, max. 100 mA PCAN-USB opto: D-Sub pin 1/pin 9 ¹ ; 5 V, max. 50 mA Not connected at delivery
Internal termination	to S/N 199999 not available, from S/N 200000 via solder bridges (not activated at delivery)

Power supply

Supply voltage	+5 V DC (via USB port)
Power consumption	max. 200 mA

¹ Pin 9 only from ser. no. 200000

Environment

Operating temperature	-40 - 85 °C (-40 - 185 °F)
Temperature for storage and transport	-40 - 100 °C (-40 - 212 °F)
Relative humidity	15 – 90 %, not condensing
Ingress protection (IEC 60529)	IP20

Measures

Size (w/o cable)	PCAN-USB: 75 x 43 x 22 mm PCAN-USB opto: 87 x 43 x 22 mm
Cable length	about 0.75 m
Weight (with cable)	PCAN-USB: 78 g PCAN-USB opto: 83 g

Conformity

EMV	Directive 2014/30/EU DIN EN 55024:2016-05 DIN EN 55032:2016-02
RoHS 2	Directive 2011/65/EU DIN EN 50581 VDE 0042-12:2013-02

Appendix A CE Certificate

EU Declaration of Conformity



This declaration applies to the following product:

Product name: PCAN-USB
Item number(s): IPEH-002021/22
Manufacturer: PEAK-System Technik GmbH
Otto-Roehm-Strasse 69
64293 Darmstadt
Germany

 We declare under our sole responsibility that the mentioned product is in conformity with the following directives and the affiliated harmonized standards:

EU Directive 2011/65/EU (RoHS 2)

DIN EN 50581 VDE 0042-12:2013-02

Technical documentation for the assessment of electrical and electronic products with respect to the restriction of hazardous substances;
German version EN 50581:2012

EU Directive 2014/30/EU (Electromagnetic Compatibility)

DIN EN 55024:2016-05

Information technology equipment – Immunity characteristics – Limits and methods of measurement (CISPR 24:2010 + Cor.:2011 + A1:2015);
German version EN 55024:2010 + A1:2015

DIN EN 55032:2016-02

Electromagnetic compatibility of multimedia equipment - Emission Requirements (CISPR 32:2015);
German version EN 55032:2015

Darmstadt, 22 February 2019

A handwritten signature in black ink, appearing to read "Uwe Wilhelm".

Uwe Wilhelm, Managing Director

Appendix B Dimension Drawings

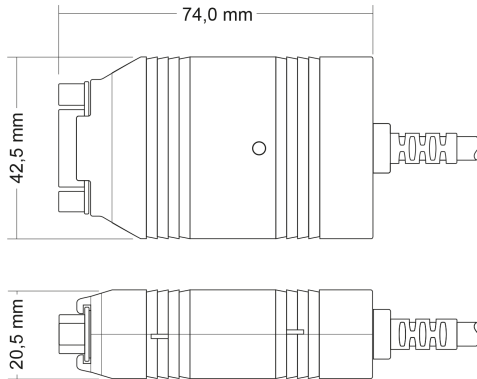

Figure 17: View PCAN-USB

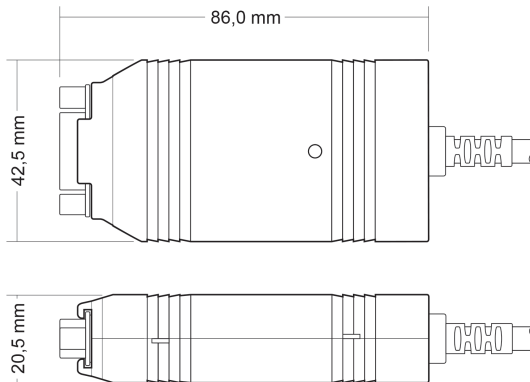

Figure 18: View PCAN-USB opto-decoupled.
The figures don't show the actual size of the product.

Appendix C Quick Reference

Software/Hardware Installation under windows

Install the driver from DVD, before you connect the PCAN-USB adapter to the computer. After that, you connect the adapter to a USB port of the computer or of a connected USB hub. The computer can remain powered on. The LED must light red.

Getting started under windows

Run the CAN monitor PCAN-View from the Windows Start menu as a sample application for accessing the adapter. For initialization of the adapter select the desired CAN interface and the CAN bit rate.

Status LED	Meaning
On	There's a connection to a driver of the operating system.
Slow blinking	A software application is connected to the adapter.
Quick blinking	Data is transmitted via the connected CAN bus.

High-speed CAN connector (D-Sub, 9 pins)

