

QuSpot for Teltonika RUT956/RUT955 ver. US (Band71)

INTEGRATED MULTI-BAND LTE & 5G OMNI ANTENNA + WI-FI OMNI ANTENNA + GPS ACTIVE ANTENNA + PLACE TO INSTALL TELTONIKA RUT956 OR RUT955 (ALL-IN-ONE)

QuSpot for **RUT956, RUT955 or RUT906 ver. US (Band71)** is an outdoor antenna designed to provide reliable wireless connectivity in a variety of environments. This product is an all in one solution that integrates a high gain omnidirectional 5G and Wi Fi antennas with RUT956, RUT955 or RUT906 into a single IP67 enclosure.

QuSpot for **RUT956, RUT955 or RUT906** is an ideal solution for outdoor wireless connectivity in moving applications such as transportation, yachting, boats and camping but also city centres with high signal density.

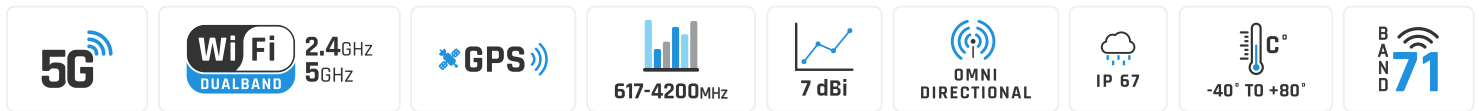

 OUTDOOR ANTENNA WORKS IN **ANY WEATHER CONDITIONS**, IP67

 ANTENNA **PERFECTLY MATCHED** WITH THE ROUTER

 **PASSIVE POE SUPPORT**

 **MADE IN EUROPE**

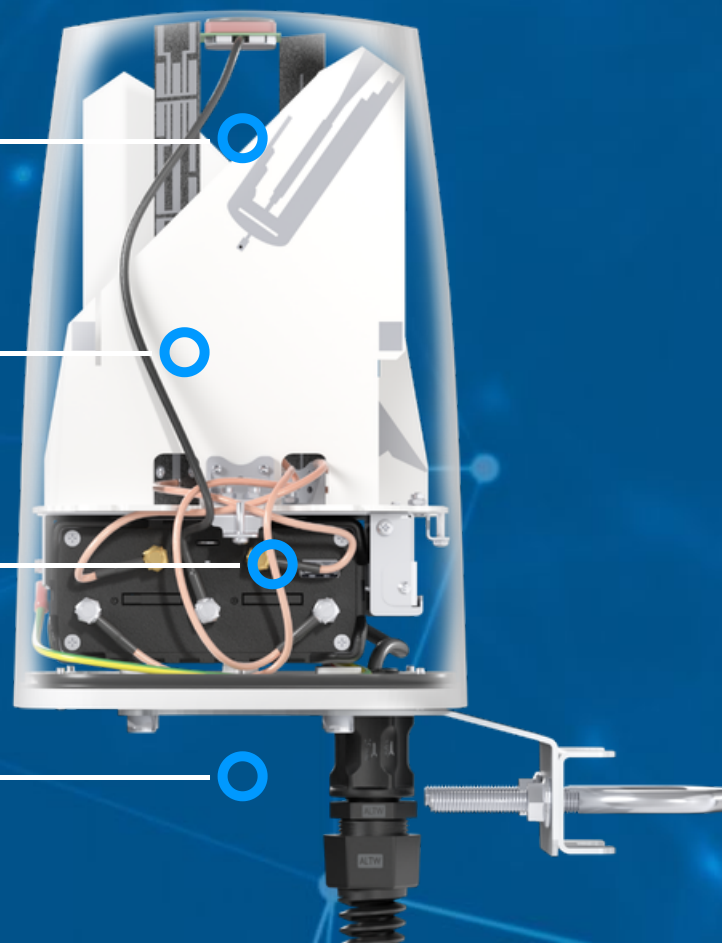

5G ANTENNA SPECIFICATION

FREQUENCY	617 - 960 MHz 1.7 - 2.7 GHz 3.3 - 4.3 GHz
GAIN	617 - 960 MHz : 2 dBi 1.7 - 2.7 GHz : 4 dBi 3.3 - 4.3 GHz : 4.5 dBi
SUPPORTED LTE BANDS	1, 2, 3, 4, 5, 7, 8, 9, 10, 12, 13, 14, 1, 2, 3, 4, 5, 7, 8, 9, 10, 12, 13, 14, 17, 18, 19, 20, 22, 25, 26, 27, 28, 29, 30, 33, 34, 35, 36, 37, 38, 39, 40, 41, 42, 43, 44, 48, 49, 52, 53, 65, 66, 67, 68, 69, 71, 85, 103, 1067, 18, 19, 20, 22, 25, 26, 27, 28, 29, 30, 33, 34, 35, 36, 37, 38, 39, 40, 41, 42, 43, 44, 48, 49, 52, 53, 65, 66, 67, 68, 69, 71, 85, 103, n77, n78, n80, n81, n82, n83, n84, n86, n89, n90, n95, n97, n98, n100, n101
VSWR	<2.00, max <2.50
BEAMWIDTH	360°/25° ±5°
POLARIZATION	Vertical
IMPEDANCE	50 Ω
CONNECTOR	2x SMA
CABLE TYPE	RG316

WI-FI ANTENNA SPECIFICATION

FREQUENCY	2.4 - 2.5 GHz 4.7 - 6 GHz
GAIN	2.4 - 2.5 GHz : 6 dBi 4.7 - 6 GHz : 7.5 dBi
VSWR	<1.70, max <2.00
BEAMWIDTH	360°/25° ±5°
POLARIZATION	Vertical
IMPEDANCE	50 Ω
CONNECTOR	2x RPSMA
CABLE TYPE	RG316

GPS ACTIVE ANTENNA SPECIFICATION

FREQUENCY	1.56 - 1.61 GHz
VSWR	< 2
GAIN	3 dBi
GAIN 3V	28 dBi
DC POWER INPUT	2.5 V ~ 6.5 V
POWER CONSUMPTION	2.5-6.5mA
IMPEDANCE	50 Ω
POLARIZATION	RHCP (right hand circularly polarized)

CONNECTOR

1x SMA

CABLE TYPE

RG174

MECHANICAL SPECIFICATION

MATERIALS

ABS, aluminum, PTFE

CONNECTOR TYPE

RJ45

INGRESS PROTECTION

IP67

DIMENSIONS

160 x 160 x 240 mm
6.3 x 6.3 x 9.45 inch

WEIGHT

1.5 kg
3.31 lbs

OPERATING TEMPERATURE

From -40°C to 75°C
From -40°F to 167°F

MAST DIAMETER

40-60 mm
1.57-2.36 inch

PLOTS

VSWR for 5G/LTE antenna

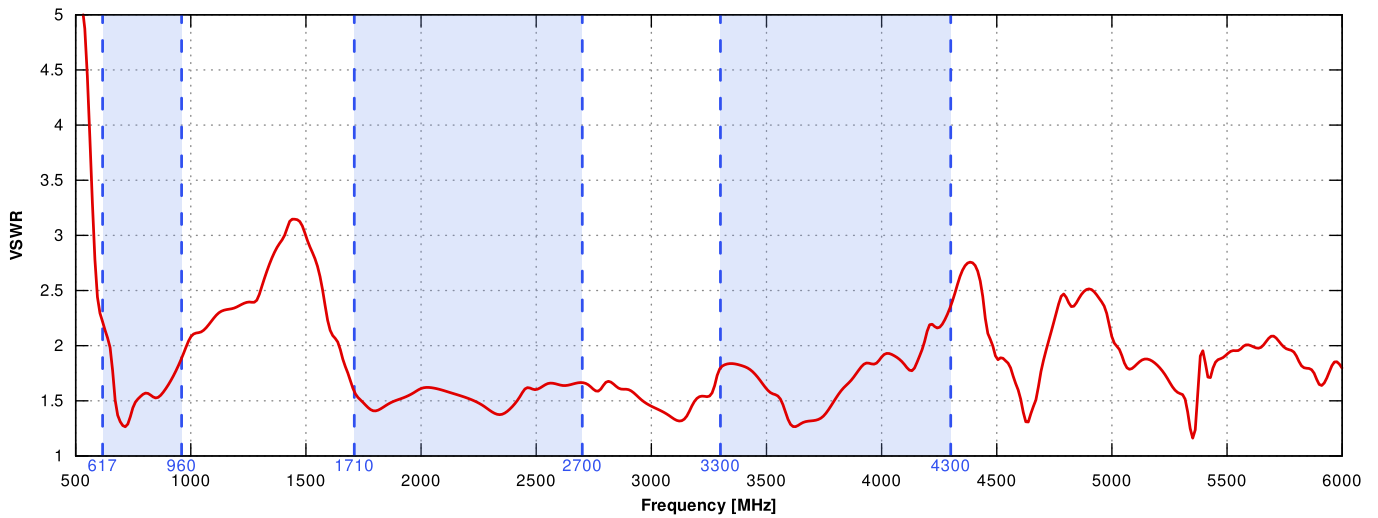

VSWR for Wi-Fi antenna

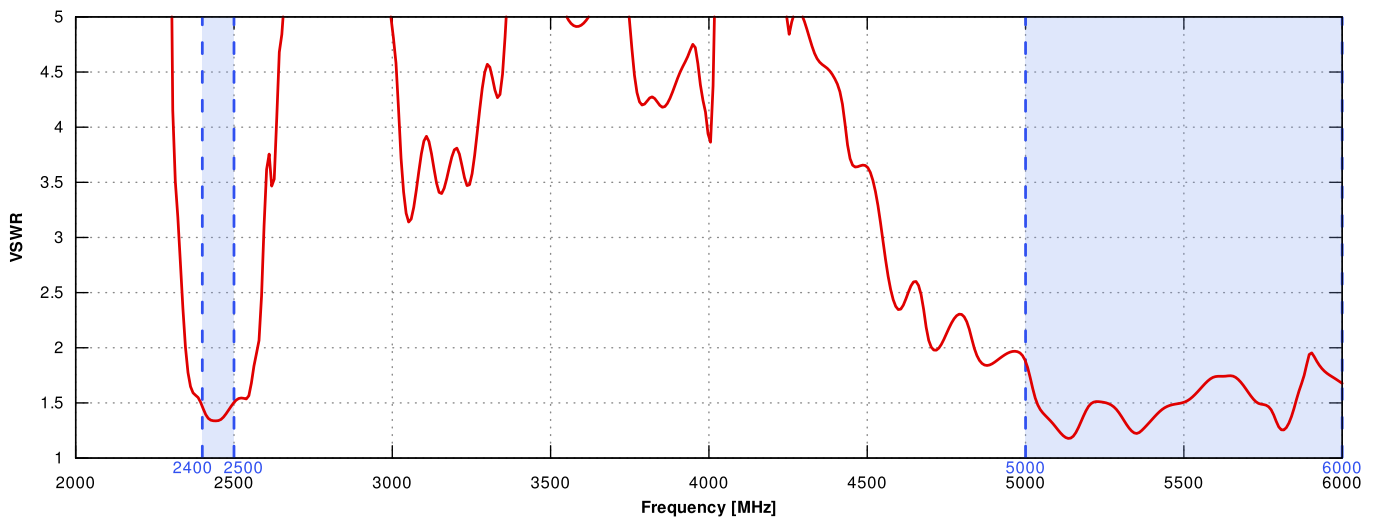

Gain for 5G/LTE antenna

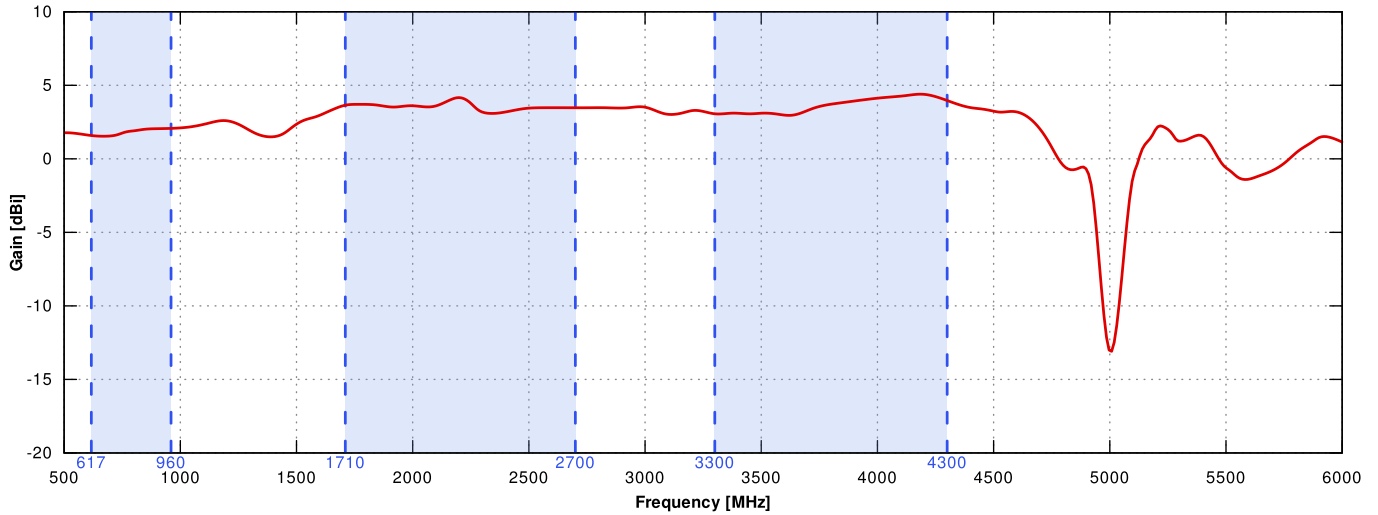

Gain for Wi-Fi antenna

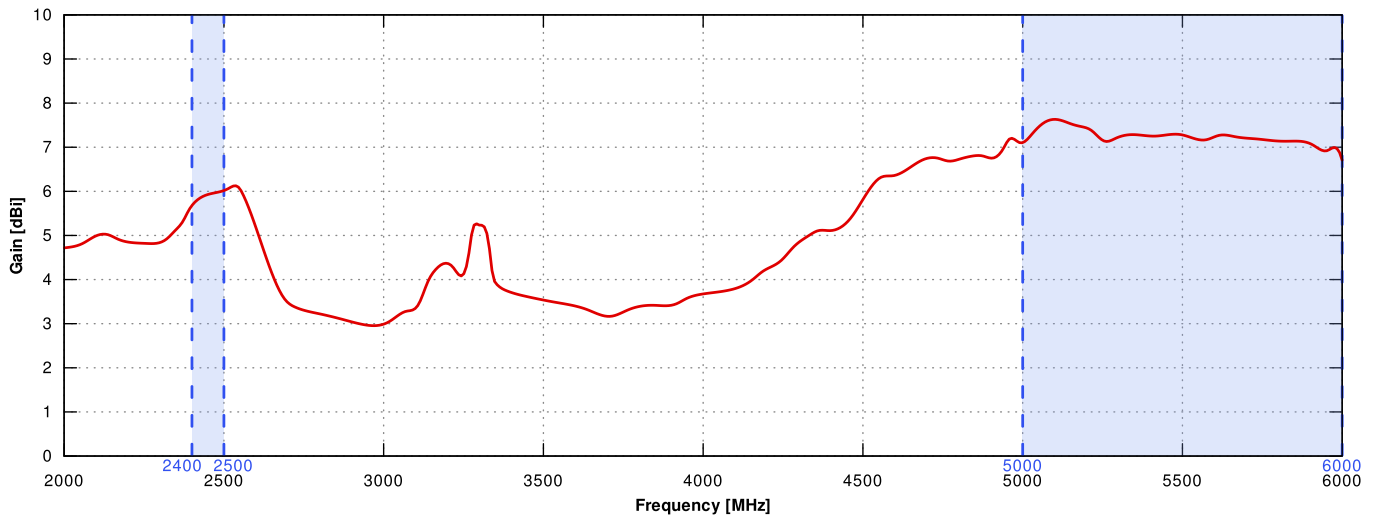

5G/LTE from 617MHz to 960MHz

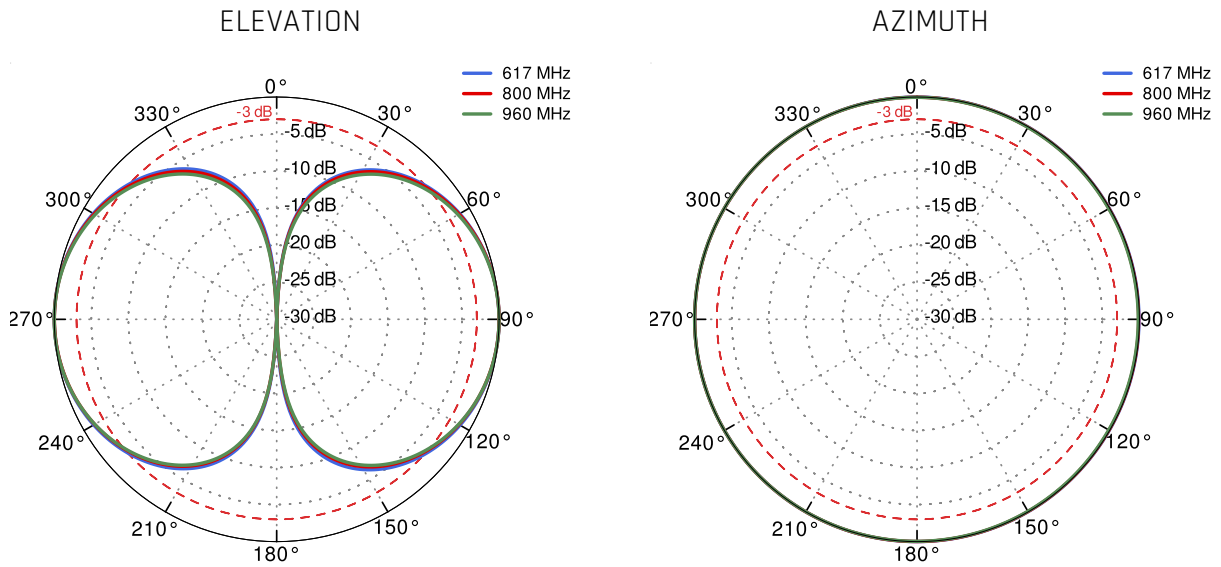

5G/LTE from 1.71GHz to 2.5GHz

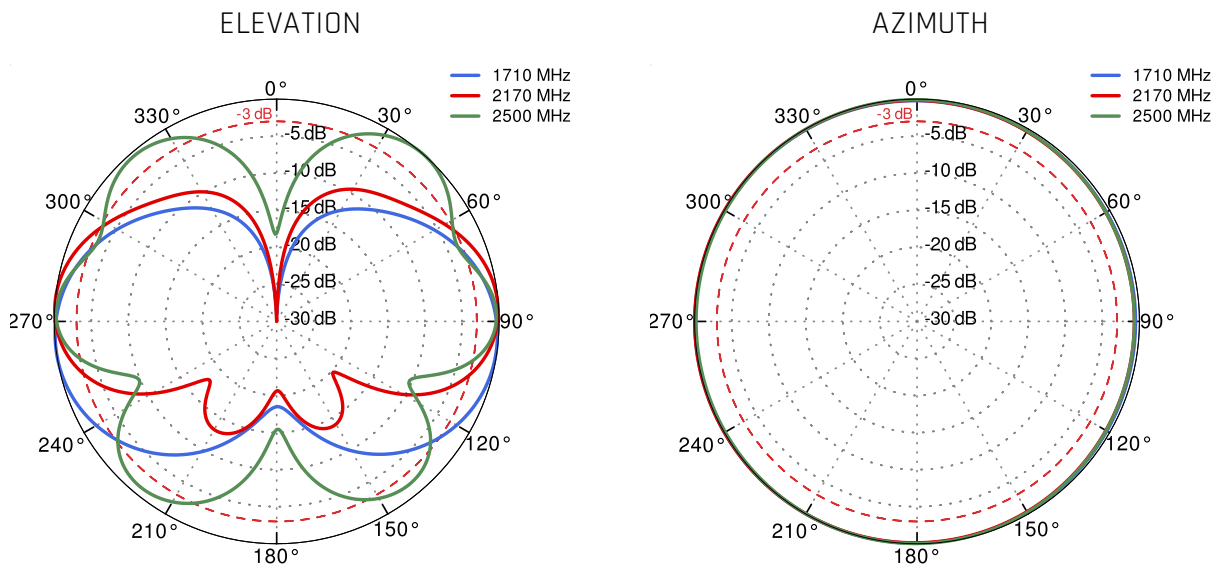

5G/LTE from 3.3GHz to 4.2GHz

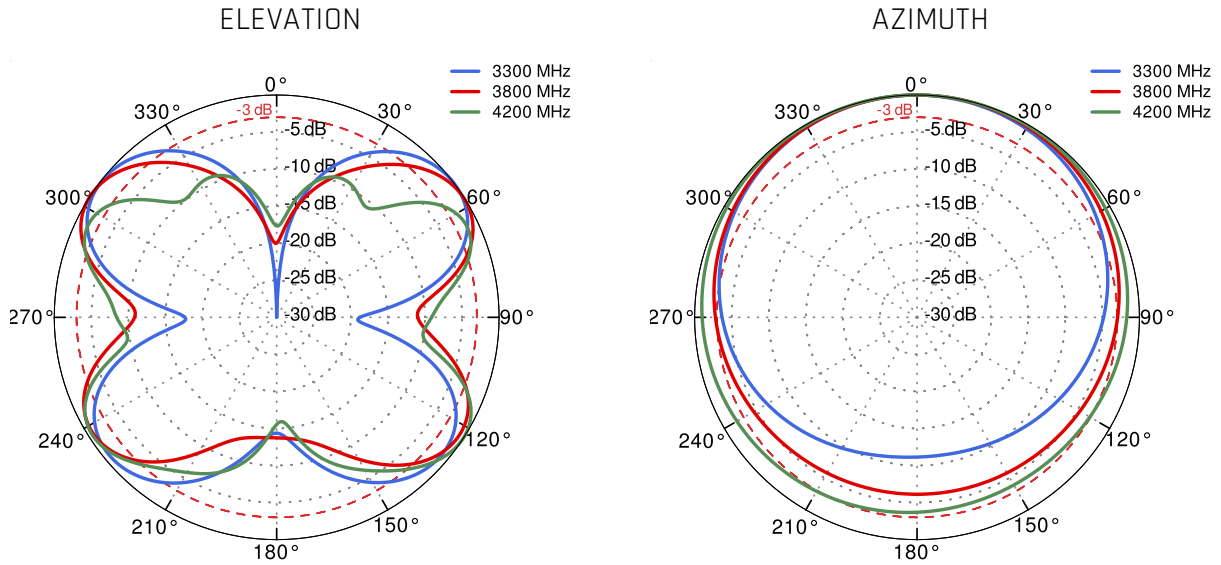

Wi-Fi 2.4 GHz and 5 GHz

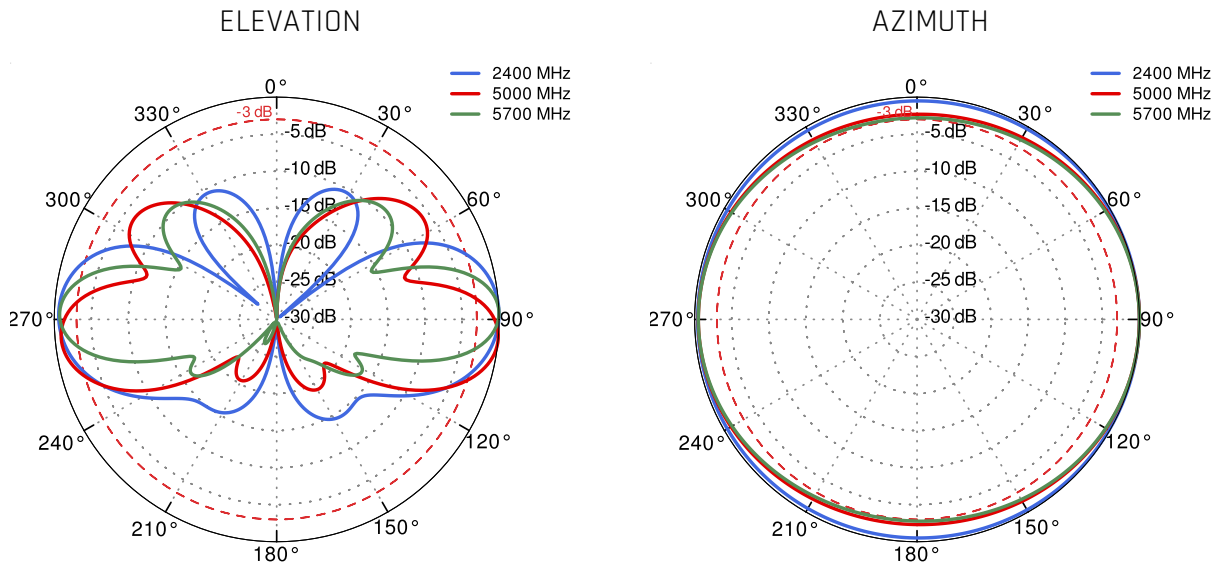

DIMENSIONS

